

STAMFORD[®]

HCI 534F/544F - Technical Data Sheet

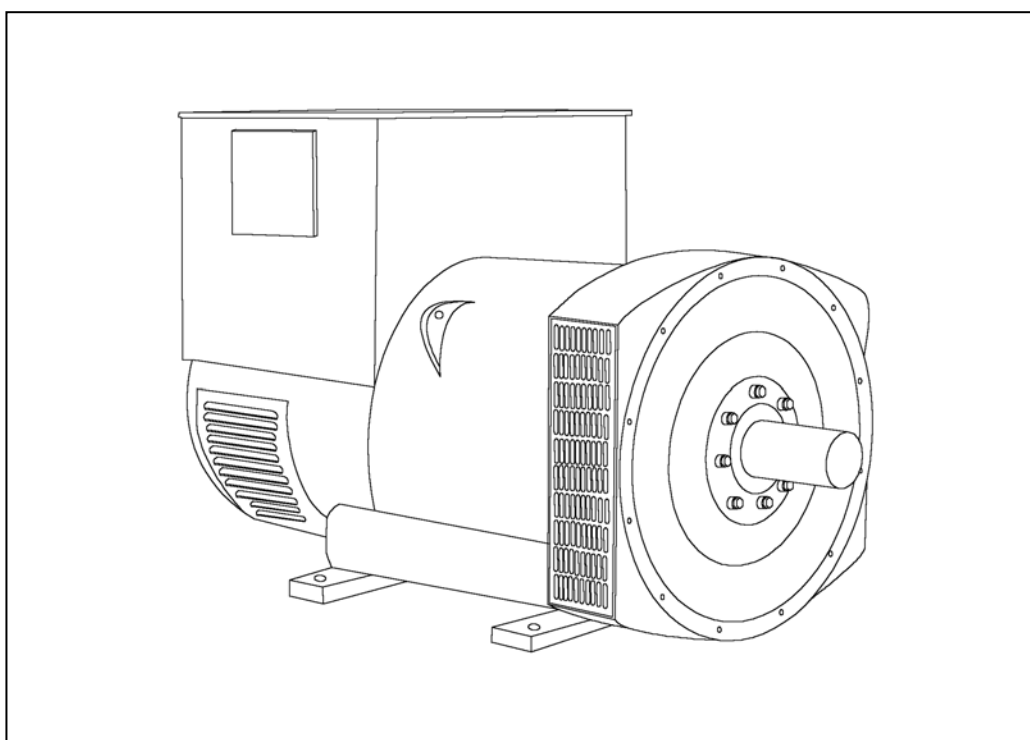

HCI534F/544F

SPECIFICATIONS & OPTIONS

STAMFORD

STANDARDS

Newage Stamford industrial generators meet the requirements of BS EN 60034 and the relevant section of other international standards such as BS5000, VDE 0530, NEMA MG1-32, IEC34, CSA C22.2-100, AS1359. Other standards and certifications can be considered on request.

VOLTAGE REGULATORS

AS440 AVR - STANDARD

With this self-excited system the main stator provides power via the Automatic Voltage Regulator (AVR) to the exciter stator. The high efficiency semi-conductors of the AVR ensure positive build-up from initial low levels of residual voltage.

The exciter rotor output is fed to the main rotor through a three-phase full-wave bridge rectifier. The rectifier is protected by a surge suppressor against surges caused, for example, by short circuit or out-of-phase paralleling.

The AS440 will support a range of electronic accessories, including a 'droop' Current Transformer (CT) to permit parallel operation with other ac generators.

MX341 AVR

This sophisticated AVR is incorporated into the Stamford Permanent Magnet Generator (PMG) control system.

The PMG provides power via the AVR to the main exciter, giving a source of constant excitation power independent of generator output. The main exciter output is then fed to the main rotor, through a full wave bridge, protected by a surge suppressor. The AVR has in-built protection against sustained over-excitation, caused by internal or external faults. This de-excites the machine after a minimum of 5 seconds.

An engine relief load acceptance feature can enable full load to be applied to the generator in a single step.

If three-phase sensing is required with the PMG system the MX321 AVR must be used.

We recommend three-phase sensing for applications with greatly unbalanced or highly non-linear loads.

MX321 AVR

The most sophisticated of all our AVRs combines all the features of the MX341 with, additionally, three-phase rms sensing, for improved regulation and performance. Over voltage protection is built-in and short circuit current level adjustments is an optional facility.

WINDINGS & ELECTRICAL PERFORMANCE

All generator stators are wound to 2/3 pitch. This eliminates triplen (3rd, 9th, 15th ...) harmonics on the voltage waveform and is found to be the optimum design for trouble-free supply of non-linear loads. The 2/3 pitch design avoids excessive neutral currents sometimes seen with higher winding pitches, when in parallel with the mains. A fully connected damper winding reduces oscillations during paralleling. This winding, with the 2/3 pitch and carefully selected pole and tooth designs, ensures very low waveform distortion.

TERMINALS & TERMINAL BOX

Standard generators are 3-phase reconnectable with 12 ends brought out to the terminals, which are mounted on a cover at the non-drive end of the generator. A sheet steel terminal box contains the AVR and provides ample space for the customers' wiring and gland arrangements. It has removable panels for easy access.

SHAFT & KEYS

All generator rotors are dynamically balanced to better than BS6861:Part 1 Grade 2.5 for minimum vibration in operation. Two bearing generators are balanced with a half key.

INSULATION/IMPREGNATION

The insulation system is class 'H'.

All wound components are impregnated with materials and processes designed specifically to provide the high build required for static windings and the high mechanical strength required for rotating components.

QUALITY ASSURANCE

Generators are manufactured using production procedures having a quality assurance level to BS EN ISO 9001.

The stated voltage regulation may not be maintained in the presence of certain radio transmitted signals. Any change in performance will fall within the limits of Criteria 'B' of EN 61000-6-2:2001. At no time will the steady-state voltage regulation exceed 2%.

NB Continuous development of our products entitles us to change specification details without notice, therefore they must not be regarded as binding.

Front cover drawing typical of product range.

HCI534F/544F



WINDING 311

CONTROL SYSTEM	SEPARATELY EXCITED BY P.M.G.		
A.V.R.	MX321	MX341	
VOLTAGE REGULATION	± 0.5 %	± 1.0 %	With 4% ENGINE GOVERNING
SUSTAINED SHORT CIRCUIT	REFER TO SHORT CIRCUIT DECREMENT CURVES (page 7)		

CONTROL SYSTEM	SELF EXCITED		
A.V.R.	AS440		
VOLTAGE REGULATION	± 1.0 %	With 4% ENGINE GOVERNING	
SUSTAINED SHORT CIRCUIT	SERIES 4 CONTROL DOES NOT SUSTAIN A SHORT CIRCUIT CURRENT		

INSULATION SYSTEM	CLASS H		
PROTECTION	IP23		
RATED POWER FACTOR	0.8		
STATOR WINDING	DOUBLE LAYER LAP		
WINDING PITCH	TWO THIRDS		
WINDING LEADS	12		
STATOR WDG. RESISTANCE	0.0037 Ohms PER PHASE AT 22°C SERIES STAR CONNECTED		
ROTOR WDG. RESISTANCE	2.16 Ohms at 22°C		
EXCITER STATOR RESISTANCE	17 Ohms at 22°C		
EXCITER ROTOR RESISTANCE	0.092 Ohms PER PHASE AT 22°C		
R.F.I. SUPPRESSION	BS EN 61000-6-2 & BS EN 61000-6-4, VDE 0875G, VDE 0875N. refer to factory for others		
WAVEFORM DISTORTION	NO LOAD < 1.5% NON-DISTORTING BALANCED LINEAR LOAD < 5.0%		
MAXIMUM OVERSPEED	2250 Rev/Min		
BEARING DRIVE END	BALL. 6220 (ISO)		
BEARING NON-DRIVE END	BALL. 6314 (ISO)		

	1 BEARING		2 BEARING	
WEIGHT COMP. GENERATOR	1685 kg		1694 kg	
WEIGHT WOUND STATOR	805 kg		805 kg	
WEIGHT WOUND ROTOR	684 kg		655 kg	
WR ² INERTIA	10.033 kgm ²		9.7551 kgm ²	
SHIPPING WEIGHTS in a crate	1775 kg		1780kg	
PACKING CRATE SIZE	166 x 87 x 124(cm)		166 x 87 x 124(cm)	
	50 Hz		60 Hz	
TELEPHONE INTERFERENCE	THF<2%		TIF<50	
COOLING AIR	1.035 m ³ /sec 2202 cfm		1.312 m ³ /sec 2780 cfm	

VOLTAGE SERIES STAR	380/220	400/231	415/240	440/254	416/240	440/254	460/266	480/277
VOLTAGE PARALLEL STAR	190/110	200/115	208/120	220/127	208/120	220/127	230/133	240/138
VOLTAGE SERIES DELTA	220/110	230/115	240/120	254/127	240/120	254/127	266/133	277/138
KVA BASE RATING FOR REACTANCE VALUES	670	670	670	650	738	775	800	825
X _d DIR. AXIS SYNCHRONOUS	2.90	2.62	2.43	2.10	3.33	3.13	2.95	2.80
X' _d DIR. AXIS TRANSIENT	0.16	0.14	0.13	0.11	0.16	0.15	0.14	0.13
X'' _d DIR. AXIS SUBTRANSIENT	0.11	0.10	0.09	0.08	0.11	0.10	0.10	0.09
X _q QUAD. AXIS REACTANCE	2.42	2.19	2.03	1.75	2.66	2.50	2.36	2.23
X'' _q QUAD. AXIS SUBTRANSIENT	0.25	0.23	0.21	0.18	0.31	0.29	0.27	0.26
X _L LEAKAGE REACTANCE	0.05	0.04	0.04	0.03	0.05	0.05	0.04	0.04
X ₂ NEGATIVE SEQUENCE	0.18	0.16	0.15	0.13	0.21	0.20	0.19	0.18
X ₀ ZERO SEQUENCE	0.08	0.08	0.07	0.06	0.09	0.08	0.08	0.08

REACTANCES ARE SATURATED VALUES ARE PER UNIT AT RATING AND VOLTAGE INDICATED

T' _d TRANSIENT TIME CONST.	0.08s
T'' _d SUB-TRANSTIME CONST.	0.012s
T' _{do} O.C. FIELD TIME CONST.	2.5s
T _a ARMATURE TIME CONST.	0.019s
SHORT CIRCUIT RATIO	1/X _d

50
Hz

HCI534F/544F
Winding 311

STAMFORD

THREE PHASE EFFICIENCY CURVES

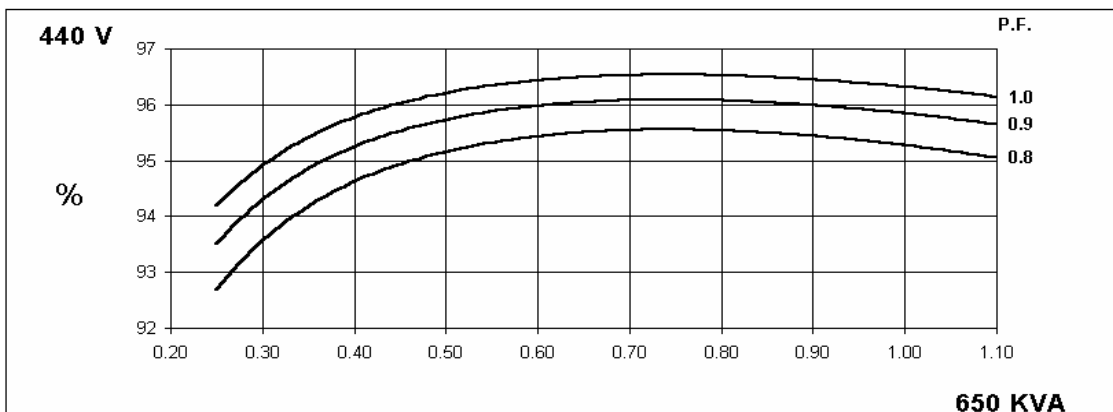
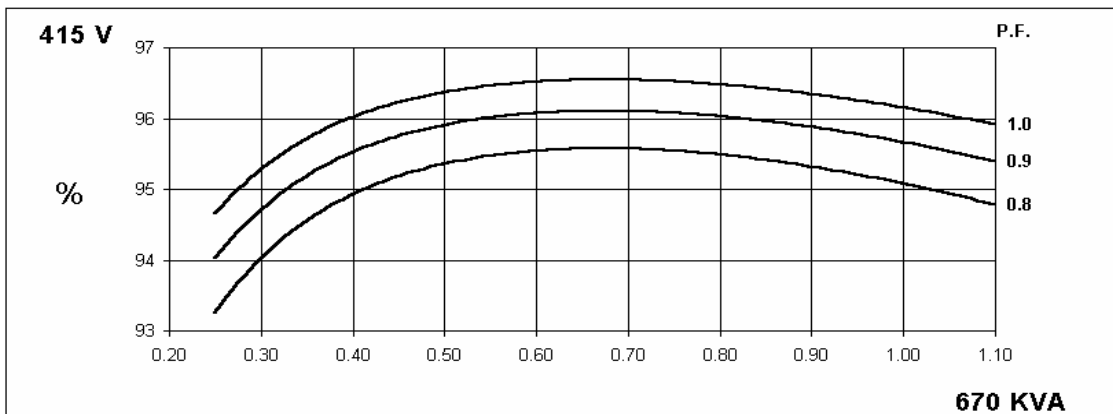
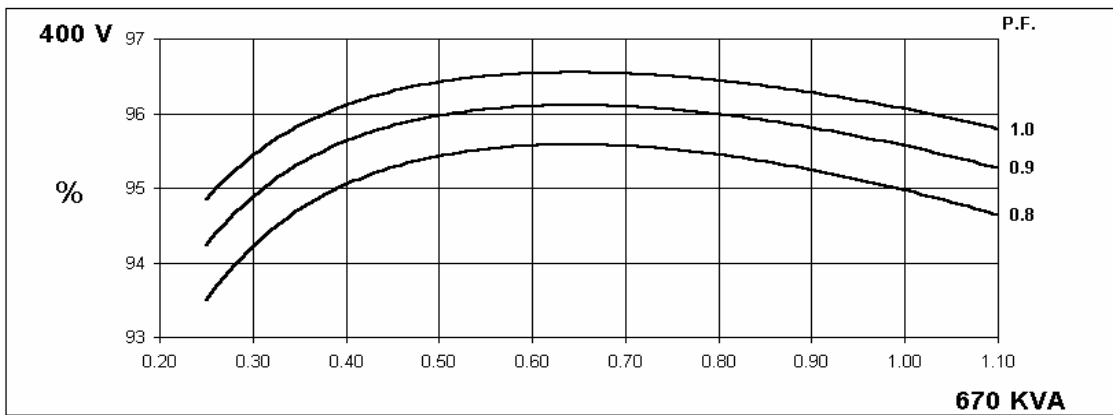
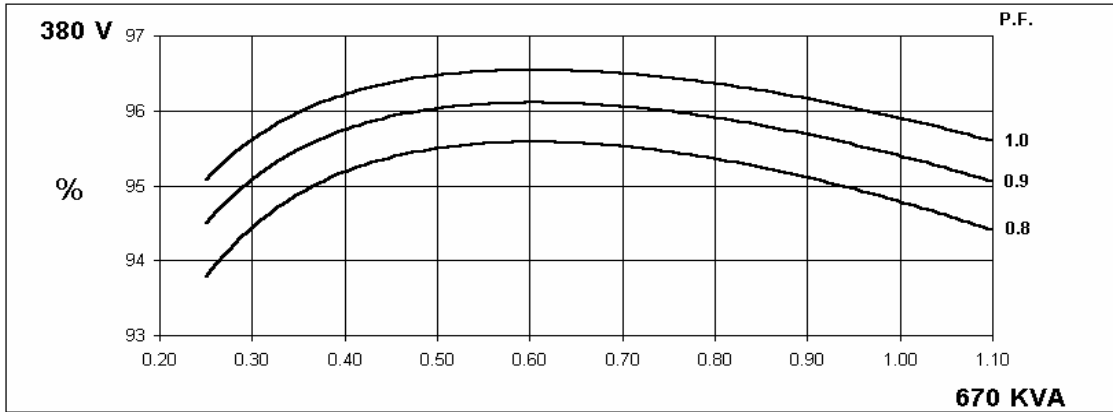

60
Hz

HCI534F/544F
Winding 311

STAMFORD

THREE PHASE EFFICIENCY CURVES

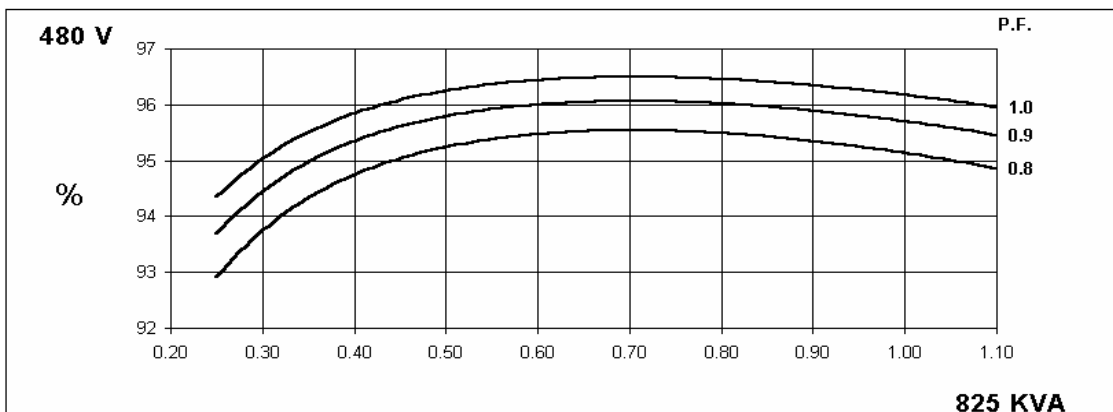
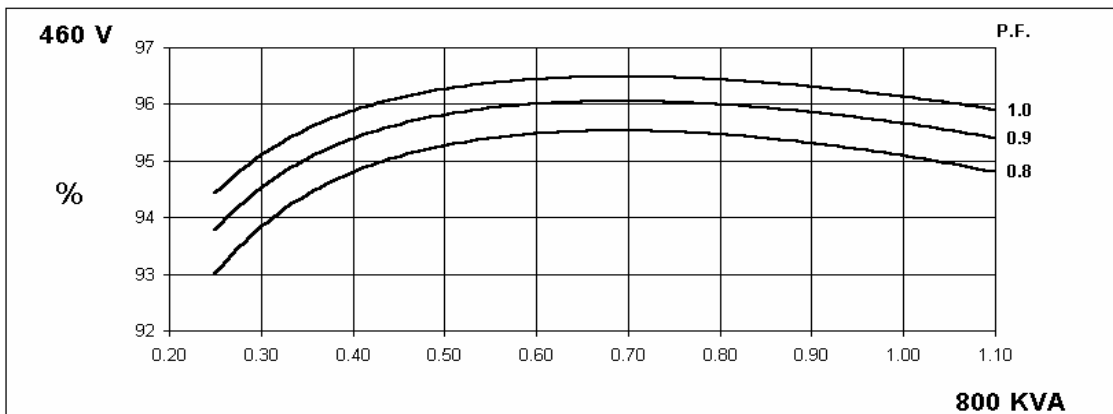
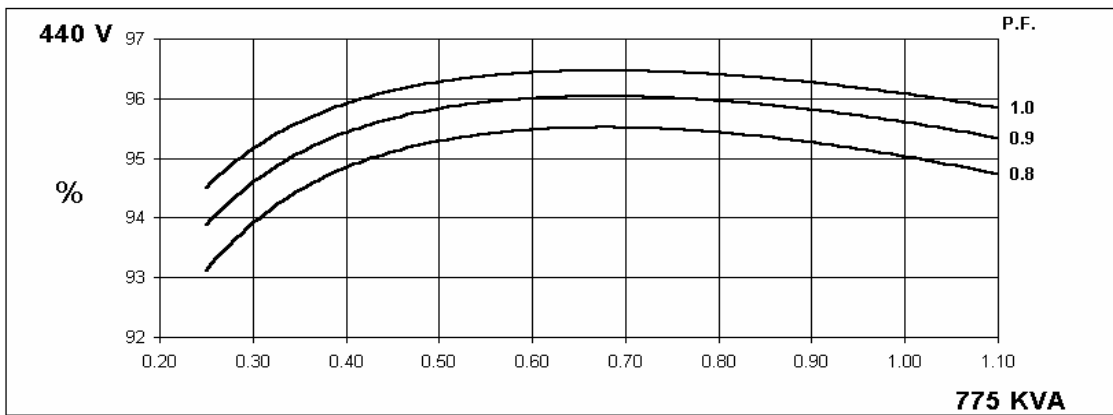
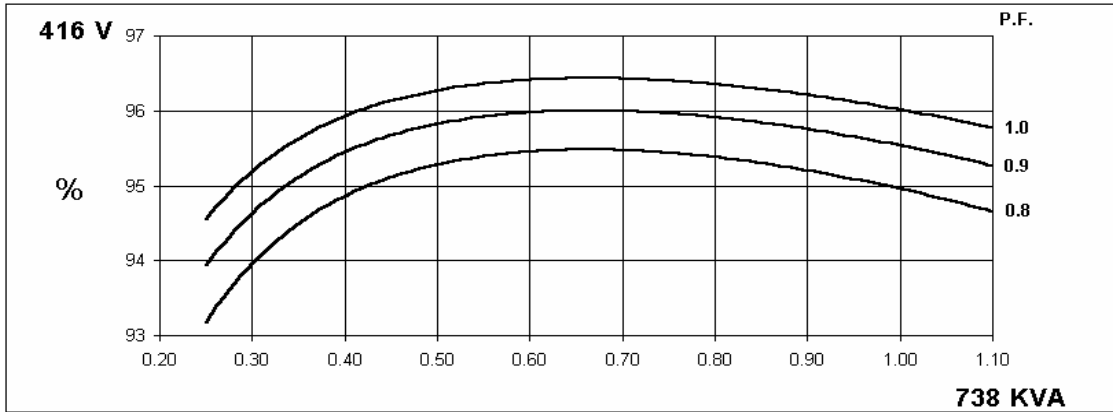

Locked Rotor Motor Starting Curve

50
Hz

MX

SX

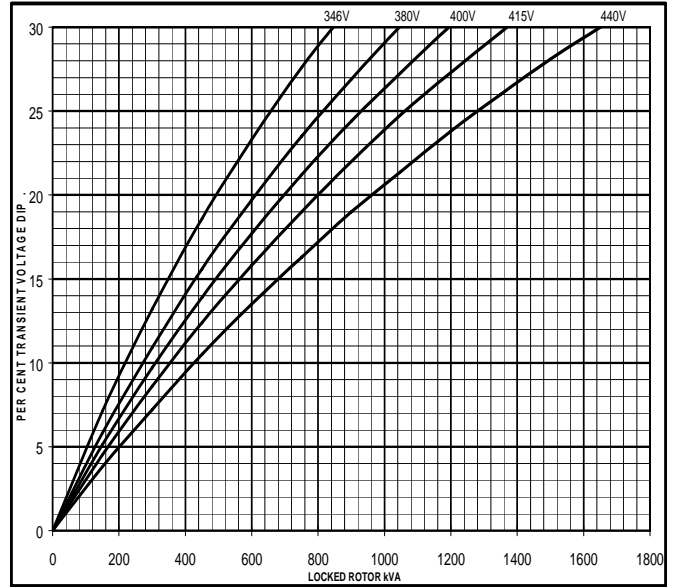
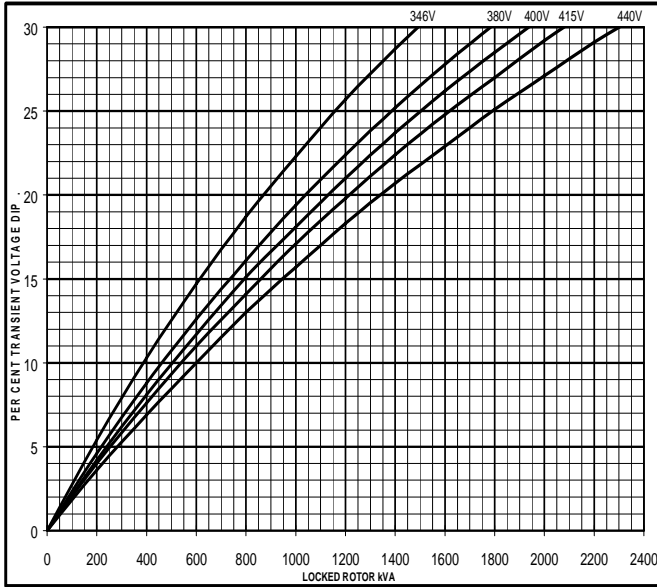

60
Hz

MX

SX

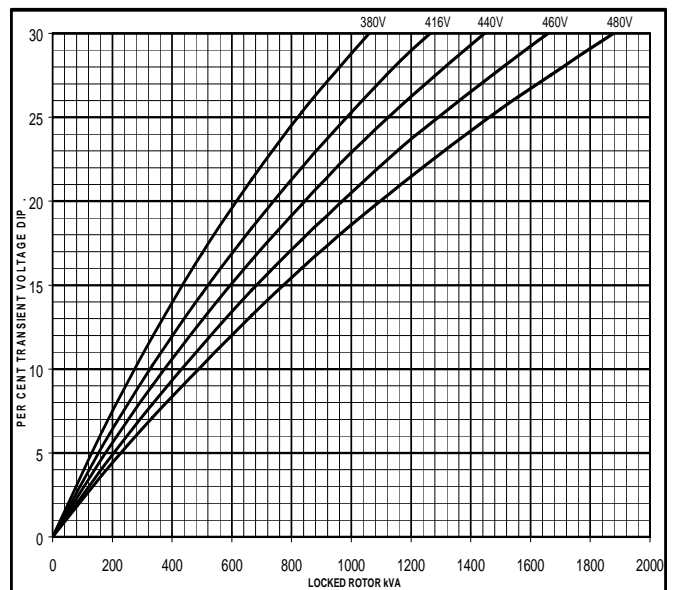
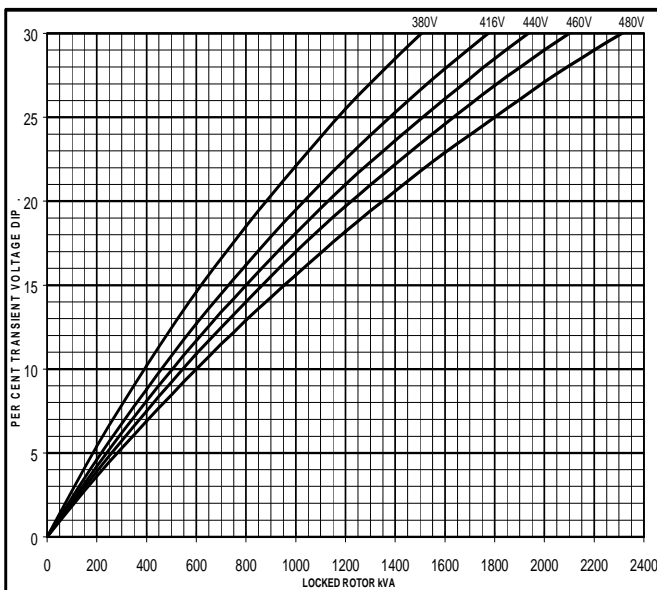

**Three-phase Short Circuit Decrement Curve. No-load Excitation at Rated Speed
Based on star (wye) connection.**

50
Hz

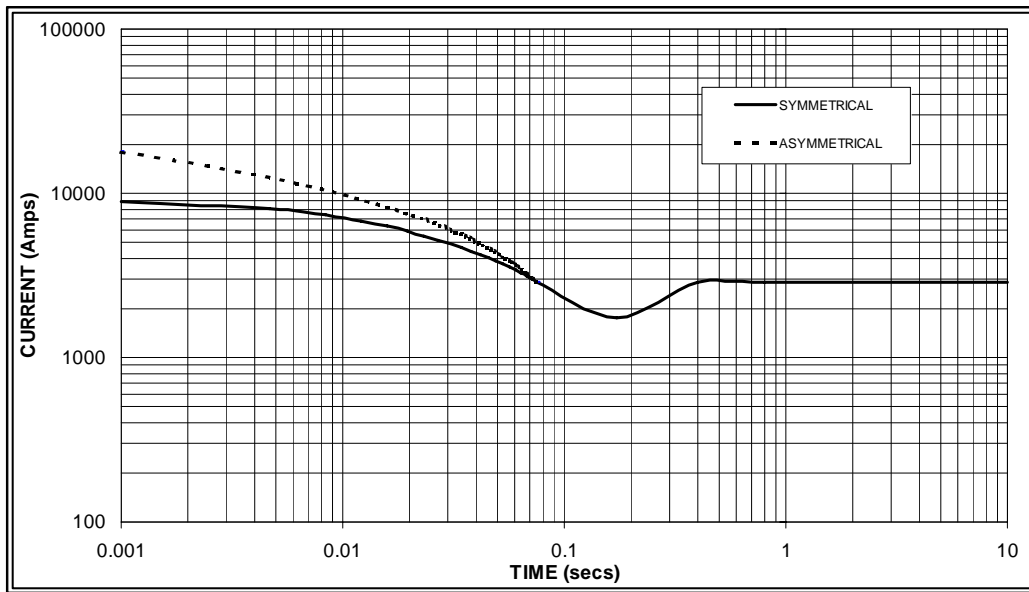

Sustained Short Circuit = 2,900 Amps

60
Hz

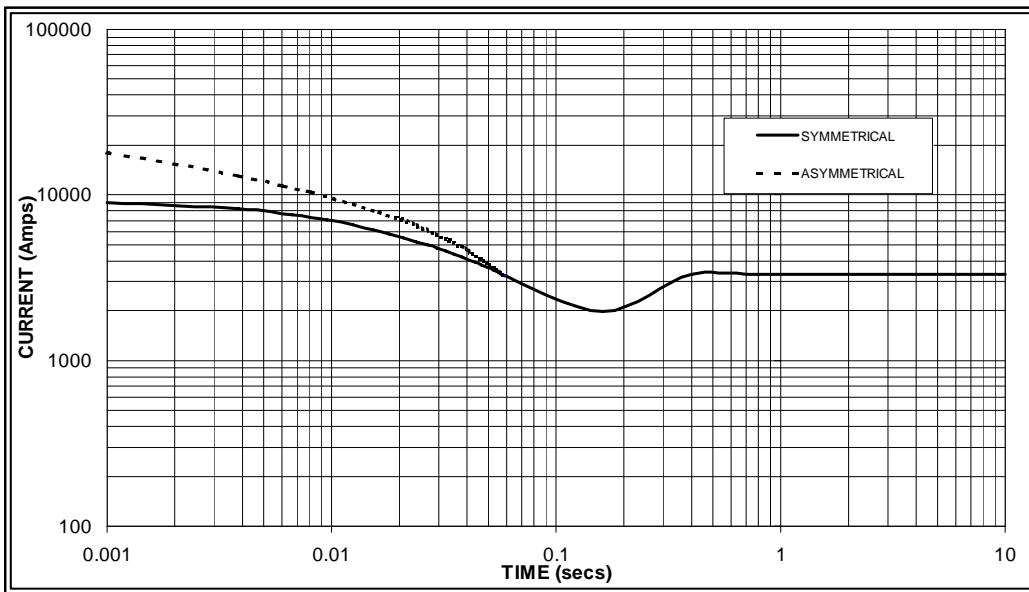

Sustained Short Circuit = 3,300 Amps

Note 1

The following multiplication factors should be used to adjust the values from curve between time 0.001 seconds and the minimum current point in respect of nominal operating voltage :

50Hz		60Hz	
Voltage	Factor	Voltage	Factor
380v	X 1.00	416v	X 1.00
400v	X 1.06	440v	X 1.06
415v	X 1.09	460v	X 1.12
440v	X 1.12	480v	X 1.20

The sustained current value is constant irrespective of voltage level

Note 2

The following multiplication factor should be used to convert the values calculated in accordance with NOTE 1 to those applicable to the various types of short circuit :

	3-phase	2-phase L-L	1-phase L-N
Instantaneous	x 1.00	x 0.87	x 1.30
Minimum	x 1.00	x 1.80	x 3.20
Sustained	x 1.00	x 1.50	x 2.50
Max. sustained duration	10 sec.	5 sec.	2 sec.

All other times are unchanged

Note 3

Curves are drawn for Star (Wye) connected machines. For other connections the following multipliers should be applied to current values as shown :

Parallel Star = Curve current value X 2

Series Delta = Curve current value X 1.732

HCI534F/544F

Winding 311 0.8 Power Factor

RATINGS

Class - Temp Rise	Cont. F - 105/40°C				Cont. H - 125/40°C				Standby - 150/40°C				Standby - 163/27°C				
50 Hz	Series Star (V)	380	400	415	440	380	400	415	440	380	400	415	440	380	400	415	440
	Parallel Star (V)	190	200	208	220	190	200	208	220	190	200	208	220	190	200	208	220
	Series Delta (V)	220	230	240	254	220	230	240	254	220	230	240	254	220	230	240	254
kVA	620	620	620	600	670	670	670	650	710	710	710	690	738	738	738	715	
kW	496	496	496	480	536	536	536	520	568	568	568	552	590	590	590	572	
Efficiency (%)	95.0	95.2	95.3	95.4	94.8	95.0	95.1	95.3	94.6	94.8	94.9	95.1	94.4	94.6	94.8	95.1	
kW Input	522	521	520	503	565	564	564	546	600	599	599	580	625	624	623	601	

60 Hz	Series Star (V)	416	440	460	480	416	440	460	480	416	440	460	480	416	440	460	480
	Parallel Star (V)	208	220	230	240	208	220	230	240	208	220	230	240	208	220	230	240
	Delta (V)	240	254	266	277	240	254	266	277	240	254	266	277	240	254	266	277
kVA	688	719	731	750	738	775	800	825	781	819	848	875	806	844	878	906	
kW	550	575	585	600	590	620	640	660	625	655	678	700	645	675	702	725	
Efficiency (%)	95.1	95.2	95.3	95.3	95.0	95.0	95.1	95.1	94.8	94.9	94.9	95.0	94.7	94.8	94.8	94.9	
kW Input	579	604	614	630	621	653	673	694	659	690	715	737	681	712	741	764	

DIMENSIONS

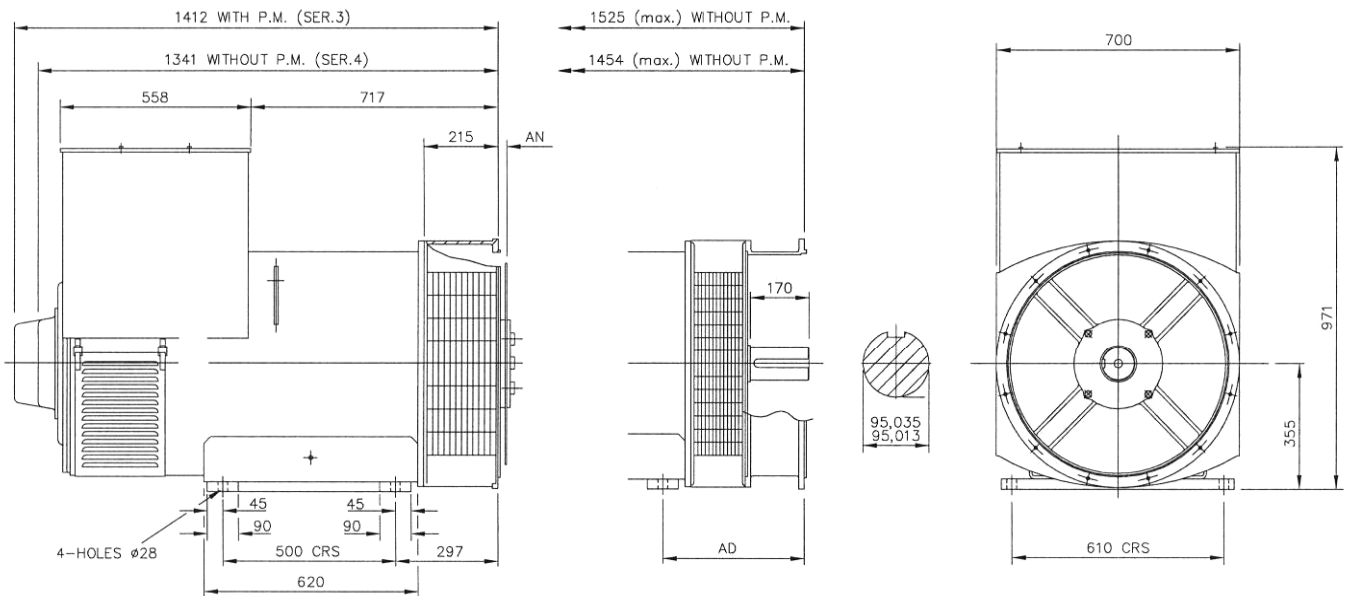

COUPLING DISC	AN
SAE 14	25,4
SAE 18	15,87
SAE 21	0

ADAPTOR	AD
SAE 00	410
SAE 0	410
SAE 1/2	390
SAE 1	390